

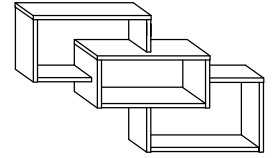

# RIO-17

## PÓLKA M

→ 85 ↑ 50 ↘ 26



x 8

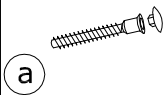

x 20

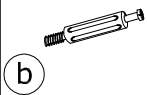

x 20

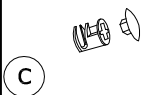

x 10

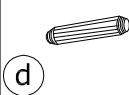

x 3 kpl.

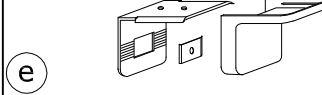

x 6

(6,2x13)



x 1

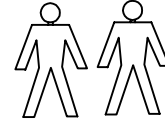

30 min



**1** - FAZY MONTAŻU

**A** - OZNACZENIE ELEMENTÓW

**a** - OZNACZENIE AKCESORIÓW

**1**

x 20



x 10



x 6

(6,2x13)

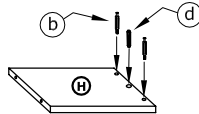
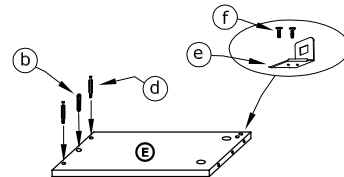
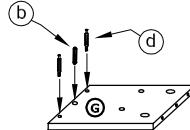
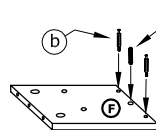
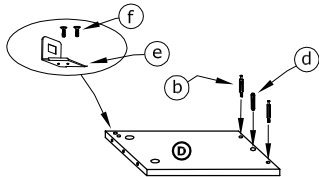
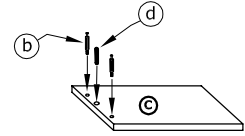
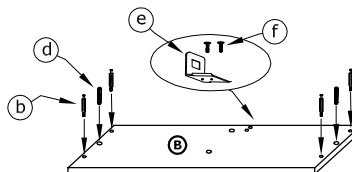
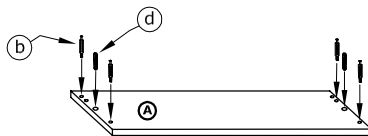

**2**

x 6



x 12

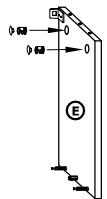
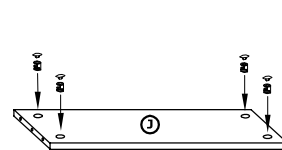
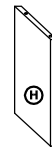
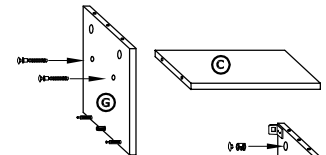
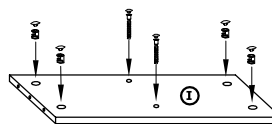
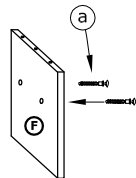
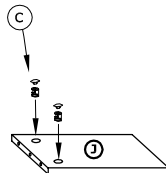
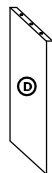

**3**

x 2



x 4

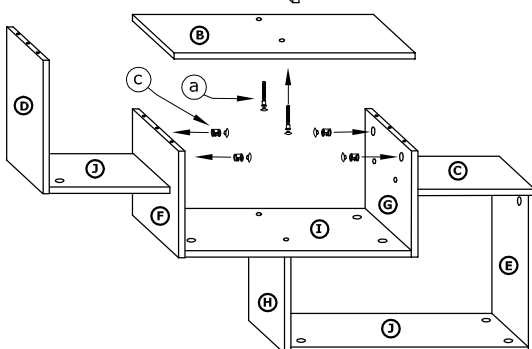

**4**

x 4

